

Article number: 2310310481ESD

Description: E+G Antistatic base for levelling elements  
LV.A-125-24-AS-M24x198-ESD-C

## Measures

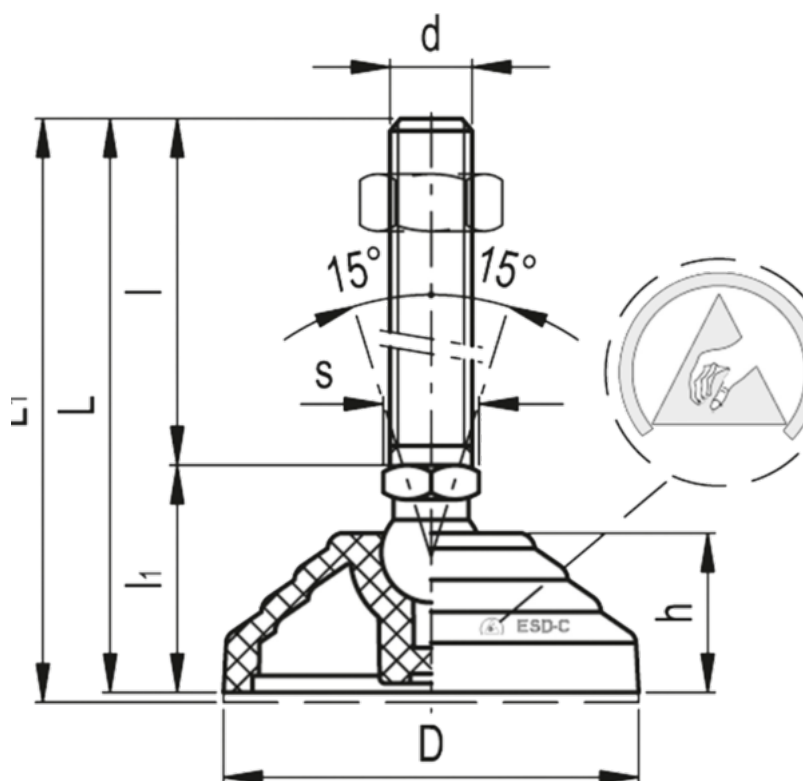

Articulation = 24	Max load = 28000
D = 125	s = 24
d = M24	Weight in (g) = 1021
h = 46	
l = 198	
l1 = 67	
L = 265	
L1 = 268	